

# Snap-tite H, IH & PH Series

General Purpose Hydraulic and  
Pneumatic Quick Couplings



## Many Standard Configurations Suitable for Hydraulic and Pneumatic Applications:

Snap-tite H Series couplings have been proven by years of use on hydraulic and pneumatic applications. H Series is best suited for general purpose fluid applications where either single or double shut-off valving is desired. A wide range of sizes, materials and end configurations are available.

PH version couplers and nipples are valved with a connect-under-pressure feature. These steel couplers and nipples allow connection with H Series valved couplers and nipples when there is residual pressure on the PH coupler/nipple side.

IH version couplers are steel with a cylindrical valve designed specifically for pneumatic use. When paired with an unvalved/plain H Series nipple, it functions as a durable single shut-off connection.



## Contact Information:

Parker Hannifin Manufacturing  
Sweden AB

**High Pressure Connectors Europe**  
Västra Skogsrovägen 1  
54106 Skövde – Sweden

phone +46 500 44 36 00  
fax +46 500 44 36 20  
tema-rfq@parker.com

[www.parker.com](http://www.parker.com)

## H Series Features:

- Sizes 1/4" - 6"
- Available in steel, brass, aluminum and 316 stainless steel
- Seal material options available
- Optional sleeve lock helps to prevent accidental disconnection
- Double shut-off version has low pressure drop
- Manually operated sleeve provides secure connection
- Couplings made of stainless steel 316 (all sizes) and steel (2-1/2" and above) are PED 2014/68/EU compliant.  
(Units with FKM seals operating with temperatures above 120°C have max operating pressure reduced by 50%. See marking "PS" and "TS" stamped on coupling parts.)



ENGINEERING YOUR SUCCESS.

# Technical and Dimensional Information

## H Series Poppet Valve

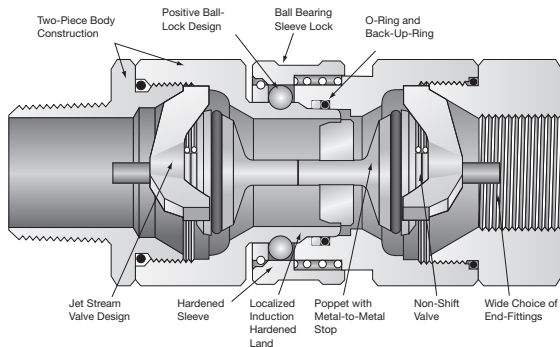

**H Series couplings** are suitable for general purpose applications and a variety of media. They are very versatile in material, size and end configuration. Valve combinations include:

- Double shut-off poppet valves
- Single shut-off (valved coupler / plain nipple)
- Straight through (unvalved/plain)

## IH Version Cylindrical Pneumatic Valve

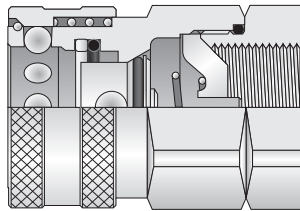

**IH version couplers** have a cylindrical valve designed specifically for pneumatic systems and reciprocating, pulsating, rotary motion air tools. The IH valve provides 360° contact when connected with an unvalved/plain H Series nipple, enabling efficient operation and long life. Available in steel, sizes 1/4", 3/8", 1/2" and 3/4".

## PH Version Connect Under Pressure Poppet Valve

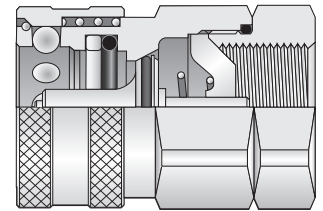

**PH version couplers and nipples** make it possible to overcome the high connection force caused by residual pressure. The poppet valves have an added pressure relief feature to allow connection under static pressures up to 3000 psi (210 bar). With a PH Series coupler or nipple installed on the pressurized line you can easily connect with a mating valved H Series. Available in steel, sizes 3/8", 1/2", 3/4" and 1".

## Working Pressures

Size	Valved on both coupler and nipple (Double Shut-off) Valved on one half and Unvalved/Plain on the other half (Single Shut-off)								Unvalved/Plain on both coupler and nipple (Straight Through)							
	Steel		Aluminium		Brass		Stainless Steel		Steel		Aluminium		Brass		Stainless Steel	
	PSI	bar	PSI	bar	PSI	bar	PSI	bar	PSI	bar	PSI	bar	PSI	bar	PSI	bar
1/4"	6.500	448	2.250	155	2.250	155	5.000	345	11.000	759	4.000	276	4.000	276	10.000	690
3/8"	4.500	310	2.250	155	2.250	155	4.000	276	11.000	759	4.000	276	4.000	276	8.000	552
1/2"	4.000	276	1.750	121	2.000	138	3.750	259	11.000	759	4.000	276	4.000	276	8.000	552
3/4"	3.500	241	1.750	121	2.000	138	2.000	138	9.000	621	3.500	241	3.500	241	7.000	483
1"	2.000	138	1.500	103	1.750	121	2.000	138	6.000	414	3.000	207	3.000	207	4.000	276
1 1/4"	1.750	121	375	26	350	24	1.500	103	5.000	345	1.000	69	1.000	69	3.000	207
1 1/2"	1.500	103	375	26	350	24	1.500	103	5.000	345	1.000	69	1.000	69	3.000	207
2"	1.500	103	300	21	400	28	500	34	4.000	276	750	52	750	52	1.000	69
2 1/2"	1.000	69	300	21	400	28	400	28	1.000	69	300	21	400	28	400	28
3"	750	52	200	14	200	14	400	28	750	52	200	14	200	14	400	28
4"	500	34	150	10	150	10	300	21	500	34	150	10	150	10	300	21

**NOTE:** Pressure ratings were established under static pressure conditions. Therefore, pressure ratings for any given flow, pressure surge and/or vibration may vary from these ratings. Burst pressures listed were taken at the point at which failure rendered the quick disconnect inoperative. (Proof pressure equals 1-1/2 times the working pressure; burst pressure equals 2 times working pressure.)

# Flow Charts

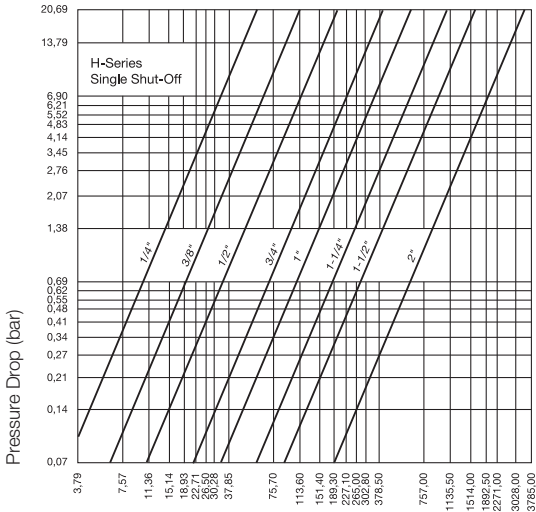

Flow Rate in l/min  
Test Media MIL-H-6083 Hydraulic Fluid at +32°C ± 1.5°C

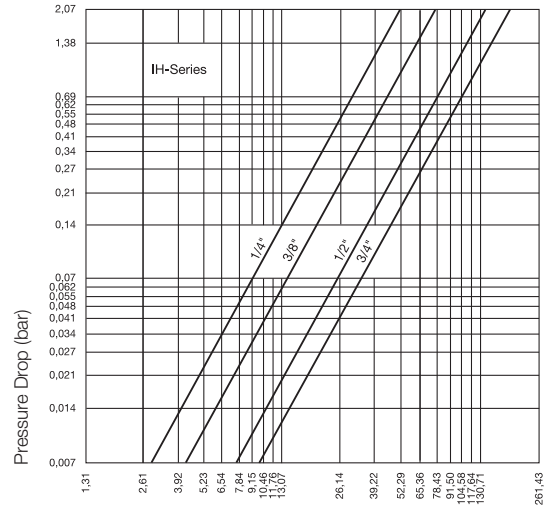

CFM free air - 1,2 bar at 21°C

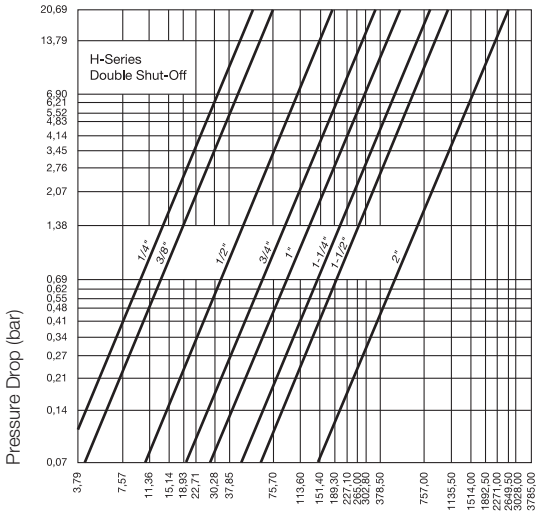

Flow Rate in l/min  
Test Media MIL-H-6083 Hydraulic Fluid at +32°C ± 1.5°C

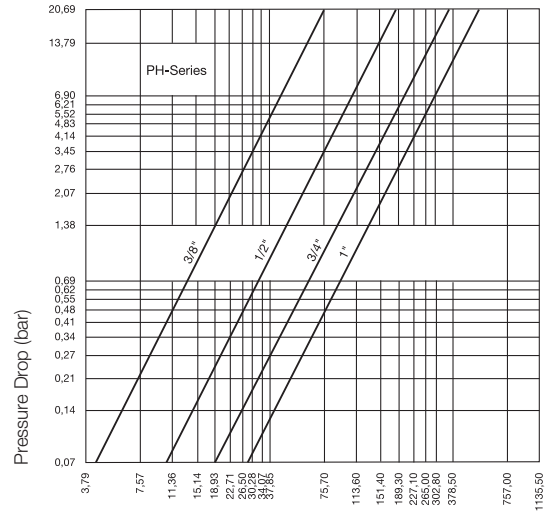





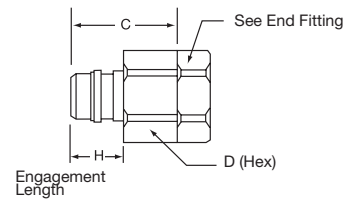
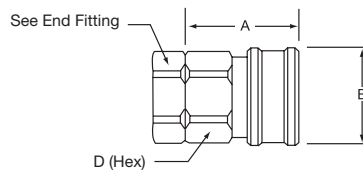

Flow Rate in l/min  
Test Media MIL-H-6083 Hydraulic Fluid at +32°C ± 1.5°C

## Valved Coupler and Nipple Dimensions (without end fitting)

Size	A mm	B mm	C mm	D' mm	H mm
1/4"	34,04	25,40	32,51	22,35	14,73
3/8"	38,10	30,23	36,58	25,40	18,03
1/2"	41,15	35,31	38,35	30,23	18,29
3/4"	48,77	41,40	45,47	38,10	22,35
1"	52,58	50,80	49,53	47,75	23,11
1 1/4"	57,91	55,63	54,61	50,80	22,86
1 1/2"	65,28	69,85	61,21	63,50	26,92
2"	79,76	88,90	74,68	85,73	33,53
2 1/2"	92,20	114,30	86,87	101,60	35,81
3"	98,55	138,13	96,27	120,65	39,62
4"	116,33	171,45	113,54	152,40	49,02



## Valved Coupler and Nipple End Fitting Dimensions

		Size	1/4"	3/8"	1/2"	3/4"	1"	1 1/4"	1 1/2"	2"	2 1/2"	3"	4"
 Male Tapered Pipe	F	mm	19,05	17,53	24,13	24,38	28,96	33,27	36,58	35,56	46,48	47,75	73,15
	G <sup>1</sup>	mm	22,35	25,40	30,23	38,10	47,75	50,80	53,50	88,90	101,60	120,65	152,40
 EM Male SAE Flared and MS33656	F	mm	18,80	18,80	21,34	28,70	29,46	32,26	37,08	43,43			
	G <sup>1</sup>	mm	22,35	33,27	30,23	38,10	47,75	50,80	63,50	88,90			
 MS33657	F	mm	31,31	33,27	37,34	46,74	46,74	49,53					
	G <sup>1</sup>	mm	22,35	25,40	30,23	38,10	47,75	50,80					
 Female Tapered Pipe	F	mm	7,87	10,16	11,94	12,70	15,24	32,00	17,78	19,81	22,86	22,35	28,70
	G <sup>1</sup>	mm	22,35	25,40	30,23	38,10	47,75	50,80	63,50	88,90	101,60	120,65	152,40
 EF Female Straight and MS33649	F	mm	11,68	17,78	14,48	25,40	22,10	28,19	21,59	25,65			
	G <sup>1</sup>	mm	22,35	25,40	30,23	38,10	47,75	50,80	63,50	88,90			
 EB Male SAE Bulk-Head	F	mm	35,30	39,62	42,42	51,56	46,74	54,36					
	G <sup>1</sup>	mm	22,35	25,40	30,23	38,10	47,75	50,80					
 Female RP British Parallel <sup>2</sup>	F	mm	9,91	10,16	13,46	14,22	15,24	32,00	17,78	19,81	22,86	22,35	28,70
	G <sup>1</sup>	mm	22,35	25,40	30,23	38,10	47,75	50,80	63,50	88,90	101,60	120,65	152,40

## Unvalved/Plain Coupler and Nipple End Configurations

Female Pipe Thread

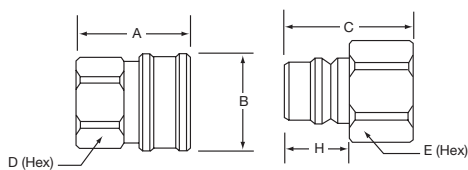

Female RP British Parallel Thread

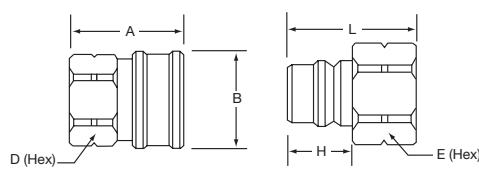

Male Pipe Thread

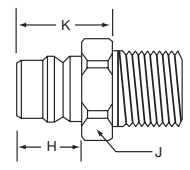

Size	A mm	B mm	C mm	D <sup>1</sup> mm	E <sup>1,2</sup> mm	H mm	K mm	J <sup>1</sup> mm	L mm
1/4"	34,04	25,40	33,53	22,35	16,00	14,73	19,81	14,22	32,26
3/8"	38,10	30,23	38,61	25,40	20,57	18,03	24,89	17,53	36,58
1/2"	41,15	35,31	43,69	30,23	25,40	18,29	25,65	22,35	43,69
3/4"	48,51	41,40	48,77	38,10	30,23	22,35	28,96	26,92	47,24
1"	52,58	50,80	53,34	47,75	38,10	23,11	29,46	35,05	54,10
1 1/4"	57,91	55,63	56,39	50,80	47,75	22,86	29,72	47,75	56,39
1 1/2"	65,28	69,85	61,98	63,50	53,98	26,92	34,04	53,98	61,98
2"	62,99	88,90	66,04	85,85	69,85	33,53	51,56	63,50	66,04
2 1/2"	78,99	114,30	74,93	95,25	82,55	35,81	52,83	82,55	74,93
3"	85,09	138,43	86,36	120,65	101,60	39,62	65,79	101,60	86,36
4"	98,55	171,45	94,74	139,70	127,00	49,02	65,53	127,00	94,74

**NOTE:**

<sup>1</sup> Dimensions taken across the hex flats. Round stock with two milled flats may be substituted for hex stock. Dimensions across flats same as dimensions across hex flats. Max O.D. of round stock will not exceed the dimensions across the points of the hex stock. Valve coupler and nipple bodies may be supplied from round bar stock without wrench flats.

<sup>2</sup> Notch on hex indicates RP British parallel threads.

## Accessories

Dust caps, dust plugs and pressure caps protect disconnected couplers and nipples from damage, dirt and other contaminants. Dust caps and dust plugs are available in plastic and clear anodized aluminum.

Plastic Cap and Plug	Aluminum Dust Caps and Plugs	Pressure Caps
<p>Designed with a loop to fit over fitting or affixing to equipment with a sheet metal screw. Available in sizes 1/4" thru 1".</p> <p>Plastic Dust Cap (PDC)      Plastic Dust Plug (PDP)</p>	<p>Aluminum dust caps and plugs are available in sizes 1/4" thru 3". The 1/4" thru 3/4" sizes come with 10" chrome plated brass bead chain. The 1" and above come with steel zinc plated sash chain.</p> <p>Metal Dust Plug (AMPH)      Metal Dust Cap (ADCH)</p>	<p>Pressure-tight pressure caps for nipples are standard in steel, Trivalent plated. Other materials such as brass, aluminum and stainless steel available on request. Sizes available 1/4" thru 3". Sizes 1/4" thru 3/4" come with 10" length of corrosion resistant steel cable. Sizes 1" thru 3" come with 12" of cable-all with adjustable loop at end of cable. Consult QCDE for special lengths.</p> <p>Metal Pressure Cap (MCH)</p>

Size	Plastic Cap	Plastic Plug	Aluminium Cap	Aluminium Plug	Pressure Cap
1/4"	PDC-4	PDP-4	ADCH-4	AMPH-4	MCH-4
3/8"	PDC-6	PDP-6	ADCH-6	AMPH-6	MCH-6
1/2"	PDC-8	PDP-8	ADCH-8	AMPH-8	MCH-8
3/4"	PDC-12	PDP-12	ADCH-12	AMPH-12	MCH-12
1"	PDC-16	PDP-16	ADCH-16	AMPH-16	MCH-16
1 1/4"			ADCH-20	AMPH-20	MCH-20
1 1/2"			ADCH-24	AMPH-24	MCH-24
2"			ADCH-32	AMPH-32	MCH-32
2 1/2"			ADCH-40	AMPH-40	MCH-40
3"			ADCH-48	AMPH-48	MCH-48

## Replacement Parts

Valve Kits	Coupler Interface Seals
<p>Includes valve, valve spring and stop. Valve seal is included in sizes 3/8" thru 1" in brass, steel, stainless steel and aluminum.</p> <p>Part Number – Use the base part number followed by SPK.</p> <p><b>Example:</b> VHC4-SPK VIHC6-SPK</p>	<p>Includes O-ring and back-up ring.</p> <p>Part Number "H (size)-56-9 (seal material)".</p> <p><b>Example:</b> H6-56-9A<sup>3</sup></p> <p>O-Ring and Back-Up-Ring</p> <p>Current Design</p>

<sup>3</sup>A" required for Nitrile Seal Kits. Refer to the part number code for other seal options.

## Standard Configurations for General Purpose Hydraulic and Pneumatic Applications

	H Series Hydraulic Coupler/Nipple	PH Series Hydraulic Coupler/Nipple	IH Series Pneumatic Coupler
Valve Styles	<ul style="list-style-type: none"> <li>Poppet Valve</li> <li>Unvalved/Plain</li> </ul>	<ul style="list-style-type: none"> <li>Connect-Under-Pressure Poppet Valve</li> </ul>	<ul style="list-style-type: none"> <li>Cylindrical Valve</li> </ul>
Connection Types	<ul style="list-style-type: none"> <li>Double Shut-off</li> <li>Single Shut-off</li> <li>Straight Through/Unvalved</li> </ul>	<ul style="list-style-type: none"> <li>Double Shut-off (connects with valved H-Series Coupler or Nipple)</li> </ul>	<ul style="list-style-type: none"> <li>Single Shut-off (connects with unvalved/plain H-Series Nipple)</li> </ul>
Body Size	<ul style="list-style-type: none"> <li>1/4" - 4"</li> </ul>	<ul style="list-style-type: none"> <li>3/8" - 1"</li> </ul>	<ul style="list-style-type: none"> <li>1/4" - 3/4"</li> </ul>
Materials	<ul style="list-style-type: none"> <li>Steel</li> <li>316 Stainless Steel</li> <li>Aluminium</li> <li>Brass</li> </ul>	<ul style="list-style-type: none"> <li>Steel</li> </ul>	<ul style="list-style-type: none"> <li>Steel</li> </ul>

# Ordering Information

**S V H C 4 - 4 F**

**Coupling Bode Size:**  
 4 = 1/4"    24 = 1 1/2"  
 6 = 3/8"    32 = 2"  
 8 = 1/2"    40 = 2 1/2"  
 12 = 3/4"    48 = 3"  
 16 = 1"    64 = 4"  
 20 = 1 1/4"    96 = 6"

**End Fitting Size:**  
 2 = 1/8"    24 = 1 1/2"  
 4 = 1/4"    32 = 2"  
 6 = 3/8"    40 = 2 1/2"  
 8 = 1/2"    48 = 3"  
 12 = 3/4"    64 = 4"  
 16 = 1"    96 = 6"  
 20 = 1 1/4"

**End Fitting Type:**  
 M = Male NPT  
 F = Female NPTF<sup>3</sup>  
 EF = Female SAE  
 EM = Male SAE 37° Flare  
 EB = Bulkhead SAE  
 RP = Female British Parallel BS2779  
 49 = MS33649 Female  
 56 = MS33656 37° Male Flare  
 57 = MS33657 Bulkhead  
 14 = MS33514 Male  
 15 = MS33515 Bulkhead

**Seals:**  
 Blank = Nitrile (Code A) (-35°C up to +120°C)  
 JF = Military variation of Nitrile for hydrocarbon fuels (-56°C up to +82°C)  
 M = Military variation of Nitrile for MIL-H-5606 fluids (-53°C up to +107°C)  
 V = Fluorocarbon (-26°C up to +204°C)  
 E = Ethylene Propylene (-56°C up to +120°C)

**Coupling Half:**  
 C = Coupling  
 N = Nipple

**Series:**  
 H = Poppet valve or plain/unvalved  
 PH<sup>1</sup> = Poppet valve with pressure relief feature  
 IH<sup>2</sup> = Pneumatic cylindrical valve

**Type:**  
 V = Valved  
 P = Plain (without valve)

**Material:**  
 Blank = Steel, clear trivalent plating  
 A = Aluminium, clear anodized  
 B = Brass  
 S = 316 Stainless Steel

**Sleeve Lock Option:**  
 SL = Helps to prevent accidental disconnection



<sup>1</sup> PH Valve option recommended on one side, not both. Available in steel only.  
<sup>2</sup> IH available in steel only.  
<sup>3</sup> For size up to 1" NPTF threads in steel.  
 For size up to 1" NPSF threads in stainless steel  
 For size over 1" NPT threads

**Notes:**

Not all configurations are standard product offering.  
 Contact your Parker sales team for price and delivery.

	H	PH	IH
<b>Double Shut-Off</b> Valved Coupler Valved Nipple	•	•	
<b>Single Shut-Off</b> Valved Coupler Unvalved/Plain Nipple	•		•
<b>Straight Through</b> Unvalved/Plain Coupler Unvalved/Plain Nipple	•		

**Parker Hannifin Manufacturing  
 Sweden AB**  
 High Pressure Connectors Europe  
 Västra Skogsrovägen 1  
 54106 Skövde – Sweden  
 Phone +46 500 44 36 00  
 Fax +46 500 44 36 20  
 www.parker.com

